

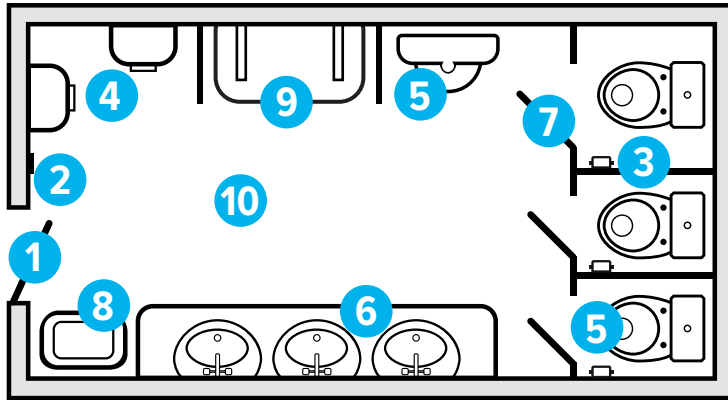









PUBLIC RESTROOM

Shared restrooms are home to numerous germs and bacteria. Keep *Everything Clean* by properly cleaning, sanitizing, and disinfecting these commonly-touched surfaces.



Key Touchpoints for cleaning include:

- 1  Door handles
- 2  Light switches
- 3  Dispensers (soap, toilet paper, etc.)
- 4  Paper towel holders
- 5  Toilet/urinals (handle, seat, etc.)
- 6  Faucet
- 7  Stall and stall handle
- 8  Trash/recycling receptacle
- 9  Changing stations
- 10  Floors/walls